

xSelector

Installation & User's Guide



Manual Rev 1.01 – July 2014
p/n 1490-00105-001

Notices and Cautions

CAUTION:

The installation and service instructions in this manual are for use by qualified personnel only. To avoid electric shock, do not perform any servicing other than that contained in the operating instructions unless you are qualified to do so. Refer all servicing to qualified personnel.

This instrument has an autoranging line voltage input. Ensure the power voltage is within the specified range of 100-240v. The ~ symbol, if used, indicates an alternating current supply.



This symbol, wherever it appears, alerts you to the presence of uninsulated, dangerous voltage inside the enclosure – voltage which may be sufficient to constitute a risk of shock.



This symbol, wherever it appears, alerts you to important operating and maintenance instructions. Read the manual.

CAUTION: DOUBLE POLE/NEUTRAL FUSING

The instrument power supply incorporates an internal fuse. Hazardous voltages may still be present on some of the primary parts even when the fuse has blown. If fuse replacement is required, replace fuse only with same type and value for continued protection against fire.

WARNING:

The product's power cord is the primary disconnect device. The socket outlet should be located near the device and easily accessible. The unit should not be located such that access to the power cord is impaired. If the unit is incorporated into an equipment rack, an easily accessible safety disconnect device should be included in the rack design.

To reduce the risk of electrical shock, do not expose this product to rain or moisture. This unit is for indoor use only.

This equipment requires the free flow of air for adequate cooling. Do not block the ventilation openings in the top and sides of the unit. Failure to allow proper ventilation could damage the unit or create a fire hazard. Do not place the units on a carpet, bedding, or other materials that could interfere with any panel ventilation openings.

If the equipment is used in a manner not specified by the manufacturer, the protection provided by the equipment may be impaired.

WARNUNG:

Die Installations- und Serviceanleitung in diesem Handbuch ist für die Benutzung durch qualifiziertes Fachpersonal. Um Stromschläge zu vermeiden führen Sie keine andere Wartung durch als in dieser Betriebsanleitung aufgeführt, es sei denn Sie sind dafür qualifiziert. Überlassen Sie alle Reparaturarbeiten qualifiziertem Fachpersonal.

Dieses Gerät hat eine automatische Bereichseinstellung der Netzspannung.
Stellen Sie sicher, dass die verwendete Netzspannung im Bereich von 100-240V liegt.
Das Symbol ~, falls verwendet, bezeichnet eine Wechselstromversorgung.



Dieses Symbol, wo immer es auftaucht, macht Sie auf nicht isolierte, gefährliche elektrische Spannung (ausreichend um einen Stromschlag hervorzurufen) innerhalb des Gehäuses aufmerksam. Spannungen.



Dieses Symbol, wo immer es auftaucht, weist Sie auf wichtige Bedienungs- und Wartungsanleitung hin. Lesen Sie die Bedienungsanleitung.

ACHTUNG: ZWEIPOLIGE ABSICHERUNG / NULLEITER ABSICHERUNG

Das Netzteil des Gerätes hat eine interne Sicherung eingebaut. Auch wenn die Sicherung durchgebrannt ist, können auf einigen primären Bauteilen noch gefährliche Spannungen vorhanden sein. Wenn ein Austausch der Sicherung erforderlich ist, ersetzen Sie die Sicherung nur mit gleicher Art und Wert für den kontinuierlichen Schutz gegen Feuer.

WARNUNG:

Das Gerätenetzkabel ist die Haupttrennvorrichtung. Die Steckdose sollte sich in der Nähe des Gerätes befinden und leicht zugänglich sein. Das Gerät sollte nicht so angeordnet sein, dass der Zugang zum Netzkabel beeinträchtigt ist. Wird das Gerät in ein Rack eingebaut, sollte eine leicht zugängliche Sicherheitstrennvorrichtung in den Rack-Aufbau mit einbezogen werden.

Um die Gefahr von Stromschlägen zu verringern, darf dieses Produkt nicht Regen oder Feuchtigkeit ausgesetzt werden. Dieses Gerät ist nur für die Benutzung im Innenbereich. Dieses Gerät erfordert freie Luftzirkulation für eine ausreichende Kühlung. Blockieren Sie nicht die Lüftungsschlitze auf der Geräteoberseite und den Seiten des Gerätes. Unzureichende Belüftung kann das Gerät beschädigen oder Brandgefahr verursachen. Platzieren Sie das Gerät nicht auf einem Teppich, Poster oder andere Materialien welche die Lüftungsöffnungen beeinträchtigen könnten.

Wird das Gerät anders als in der, vom Hersteller angegebenen Weise verwendet, kann der, durch das Gerät gegebene Schutz beeinträchtigt werden.

USA CLASS A COMPUTING DEVICE INFORMATION TO USER. WARNING:

This equipment generates, uses, and can radiate radio-frequency energy. If it is not installed and used as directed by this manual, it may cause interference to radio communication. This equipment complies with the limits for a class a computing device, as specified by fcc rules, part 15, subpart j, which are designed to provide reasonable protection against such interference when this type of equipment is operated in a commercial environment. Operation of this equipment in a residential area is likely to cause interference. If it does, the user will be required to eliminate the interference at the user's expense. Note: objectionable interference to tv or radio reception can occur if other devices are connected to this device without the use of shielded interconnect cables. Fcc rules require the use of shielded cables.

CANADA WARNING:

“This digital apparatus does not exceed the class a limits for radio noise emissions set out in the radio interference regulations of the Canadian department of communications.”

“Le présent appareil numérique n'émet pas de bruits radioélectriques dépassant les limites applicables aux appareils numériques (de class a) prescrites dans le règlement sur le brouillage radioélectrique édicté par le ministère des communications du Canada.”

CE CONFORMANCE INFORMATION:

This device complies with the requirements of the EEC council directives:

- 93/68/EEC (CE MARKING)
- 73/23/EEC (SAFETY – LOW VOLTAGE DIRECTIVE)
- 89/336/EEC (ELECTROMAGNETIC COMPATIBILITY)

Conformity is declared to those standards: EN50081-1, EN50082-1.

xSelector Manual

© 2014-2015 TLS Corp. Published by Axia Audio/TLS Corp. All rights reserved.

TRADEMARKS

Axia Audio, the Axia logo and xSelector are trademarks of TLS Corp.. All other trademarks are the property of their respective holders.

NOTICE

All versions, claims of compatibility, trademarks, etc. of hardware and software products not made by Axia Audio which are mentioned in this manual or accompanying material are informational only. Axia makes no endorsement of any particular product for any purpose, nor claims any responsibility for operation or accuracy. We reserve the right to make improvements or changes in the products described in this manual which may affect the product specifications, or to revise the manual without notice.

WARRANTY

This product is covered by a five year limited warranty, the full text of which is included in this manual.

UPDATES

The operation of xSelector is determined largely by software. We routinely release new versions to add features and fix bugs. Check the Axia Audio web site for the latest. We encourage you to sign-up for the email notification service offered on the site.

FEEDBACK

We welcome feedback on any aspect of xSelector, or this manual. In the past, many good ideas from users have made their way into software revisions or new products. Please contact us with your comments.

SERVICE

You must contact Axia before returning any equipment for factory service. We will need your unit's serial number, located on the back of the unit. Axia will issue a return authorization number, which must be written on the exterior of your shipping container. Please do not include cables or accessories unless specifically requested by the Technical Support Engineer. Be sure to adequately insure your shipment for its replacement value. Packages without proper authorization may be refused. US customers, please contact Axia Technical Support at +1-216-622-0247. All other customers should contact local representative to make arrangements for service.

We Support You...

BY PHONE / FAX:

- You may reach our 24/7 Support team anytime around the clock by calling +1-216-622-0247.
- For billing questions or other non-emergency technical questions, call +1-216-241-7225 between 9:30 am to 6:00 PM, USA Eastern time, Monday through Friday.
- Our Fax number is +1-216-241-4103.

BY E-MAIL:

- Technical support is available at support@AxiaAudio.com.
- All other questions, please email inquiry@AxiaAudio.com.

VIA WORLD WIDE WEB:

The Axia Audio web site has a variety of information which may be useful for product selection and support. The url is www.AxiaAudio.com.

REGISTER YOUR PRODUCT

Did you know that all Telos Alliance products come with a 5-Year Warranty? Take a moment to activate your coverage online at <http://telosalliance.com/product-registration/>.

AXIA AUDIO

1241 Superior Avenue E.
Cleveland, OH., 44114 USA

+1-216-241-7225 (phone)
+1-216-241-4103 (fax)
+1-216-622-0247 (24/7 technical support)

support@AxiaAudio.com
Inquiry@AxiaAudio.com

Table of Contents

| | | | |
|---|-----------|--|-----------|
| <i>Notices and Cautions</i> | ii | Advanced Options – System page | 31 |
| <i>xSelector Support</i> | vi | <i>IP Settings</i> | 32 |
| <i>A Note From The Vice President</i> | ix | <i>User password</i> | 33 |
| | | <i>Firmware Version</i> | 33 |
| | | Performing a Reset to Factory Default Settings | 34 |
| Quickstart: Fast Setup | 1 | Appendix A: GPIO Tables | 35 |
| Fast Setup Using Axia iProbe Software | 2 | Appendix B: Unbalanced Connections | 43 |
| Fast Operation | 3 | Appendix C: Specifications | 45 |
| <i>Front Panel</i> | 3 | Warranty | 47 |
| <i>Rear Panel</i> | 4 | | |
| Chapter One: Introducing the xSelector? | 5 | | |
| xSelector Features | 5 | | |
| Front Panel Controls & Indicators | 6 | | |
| Rear Panel Connections | 7 | | |
| Web Interface | 9 | | |
| Chapter Two: Using xSelector | 11 | | |
| Power Up! | 11 | | |
| Basic Operation | 11 | | |
| <i>Selecting a Stream to Record, Store or Play</i> | 11 | | |
| <i>Programming And Using the Fast Selection keys</i> | 12 | | |
| <i>Adjusting Output Volume</i> | 13 | | |
| Advanced Operation | 13 | | |
| <i>GPIO Page</i> | 13 | | |
| <i>Node ID Page</i> | 14 | | |
| <i>IP Address Page</i> | 15 | | |
| <i>Title Page</i> | 16 | | |
| <i>Meters Page</i> | 16 | | |
| Chapter Three: In Depth / Advanced Programming | 19 | | |
| Accessing xSelector's Web Pages | 19 | | |
| <i>Login/Password</i> | 19 | | |
| The xSelector Home Page | 20 | | |
| Simple Setup Page | 21 | | |
| Advanced Options Screens | 23 | | |
| <i>Advanced Options – Sources</i> | 23 | | |
| <i>Advanced Options – Destinations</i> | 25 | | |
| Advanced Options – Meters Page | 26 | | |
| QoS Page | 27 | | |
| <i>Synchronization</i> | 28 | | |
| <i>Live Audio/Clock Streams</i> | 30 | | |
| <i>Standard Audio Streams</i> | 30 | | |

*CAT.6, small and light
yet sound and data pour forth.
What magic is this?.*

A Note From The Vice President of Axia

2013 marks a banner year for Axia — this year marks the first decade of the Connected Studio.

In retrospect, it's hard to believe it's been 10 years since a start-up division of Telos grabbed everyone's attention with a radical idea about building radio studios using Ethernet. At a time when "state of the art" meant discrete digital audio, and a routing switcher was something only the richest stations could afford, Axia shocked everyone with the idea that studio peripherals from the console to the audio processor could be networked, and that everyone could have the benefits of a routing switcher — for about a third of the cost of traditional technology.

When we launched Axia, Telos founder Steve Church made a prediction. "Three things will happen," Steve told us. "First, people will say that 'it will never work.' When they're proven wrong, they'll say 'It works, but you don't need that.' And finally, as they see Axia becoming successful, they'll say 'IP-Audio? We do that too!'"

Steve, as always, was right on the money. In 10 years, Axia Livewire has become the world's most popular IP-Audio networking technology, and our mixing consoles are the world's best-selling — they're on-air in over 4,000 studios, and counting. You'll find Axia equipment everywhere: at privately-owned stations, and large clusters run by big conglomerates. At established public broadcasters, and at newly-licensed International stations. At government broadcast facilities, and podcast studios. Needless to say, we're humbled by the trust broadcasters place in us — and by your enthusiasm!

Being first with new technology is nice, but we've never been content to rest on our laurels. So the Telos R&D team continues to innovate and expand the scope

of IP-Audio. Axia consoles are the first and only IP-Audio consoles with a pre-configured network switch built in, to save broadcasters the effort and expense of procuring and programming third-party switches. Our compact xNode AoIP interfaces feature one-button setup, and can run on mains power or Power over Ethernet (PoE) for flexibility and redundancy. We've even developed our own zero-configuration Ethernet switch for Livewire — xSwitch — to make deploying IP-Audio easier than ever.

More than 45 Livewire partners believe in the vision of the Connected Studio too. Collectively, they make dozens of hardware and software products (ranging from telephone systems to audio processors to program automation) that interoperate directly with Axia networks via Ethernet — making the connections "smart", and eliminating the need to purchase audio conversion devices. We've also partnered with the high-performance audio standard RAVENNA to expand broadcasters' networking options even further. And there are a lot more great new ideas in the cooker — so watch this space!

In the final analysis, Axia's success isn't due to our efforts. It's you, the broadcast professional, who has embraced our vision, used our technology in ways we never dreamed of, and raved about Axia products to everyone who'd listen. We owe you a huge debt of thanks. And we promise to never stop trying to amaze and delight you.

So here's to the next 10 years.
Onward and upward!

Marty Sacks
Vice President, Axia Audio



Quickstart

Fast Setup



Thanks for purchasing xSelector! Like all Axia xNodes, xSelector has a one-minute Fast Setup capability that automatically assigns a network IP Address and Livewire Output Channel based upon a two-digit ID Number you assign. Here's how:

1. **Apply power** to the xSelector and let it boot. You'll see a title screen in a few seconds.
2. **Push in the knob on the right side** 3 times, or until the screen says 'Node' in the top left corner.
3. **Push in the knob on the right and hold it for 10 seconds.** You will see the Page icon highlight; as you continue to hold, the Pencil icon will highlight. You're now in Edit Mode, as shown in the photo below. Release the knob.

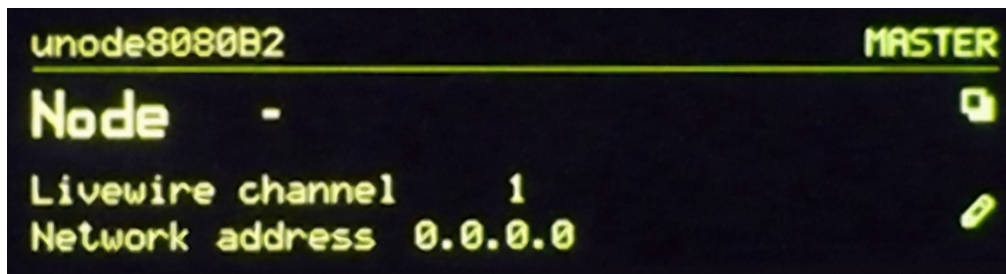

4. **Give your xSelector an ID number.** Rotate the knob to change the numerical value at the cursor. When you've got the value you want, Press the knob once to move to the next position.

Example: Press the knob once, rotate it one click clockwise to enter the numeral "1". Press the knob again; the cursor moves to the right and a "0" appears; you've entered an ID number of "10."

5. **Press the knob again** to exit Edit Mode. With the value of 10 assigned, your xSelector has an IP address of 10.216.0.110 and a Livewire channel of 1001. If you'd entered "11", it would have an IP address of 10.216.0.111 and a Livewire channel of 1101. See how it works?
6. **You're done!** Attach xSelector to your network using one of the rear-panel Livewire™ ports, and begin selecting sources.

Fast Setup Using Axia iProbe Software

iProbe is a software utility developed by Axia that provides management, support and control of Livewire devices. It is not included with xSelector, but can be purchased separately. iProbe simplifies a lot of the work of administering an Axia network by scanning and collecting information from connected Livewire devices, and presenting it in a graphical interface.

When an xSelector boots and it has no configuration, it will broadcast a BootP request within 4 seconds. The broadcasts will continue, with an increasing delay between messages, until a configuration is set.

If your computer is running iProbe when xSelector's BootP request is issued, it will sense the request and offer you the option to respond or ignore. A counter at the bootstrap configuration button will appear when a BootP request is received by iProbe (version 1.2). Clicking on the button will open the Device Bootstrap and Configuration window. From the window view, select the device that has issued the BootP request (presumably your new xSelector).

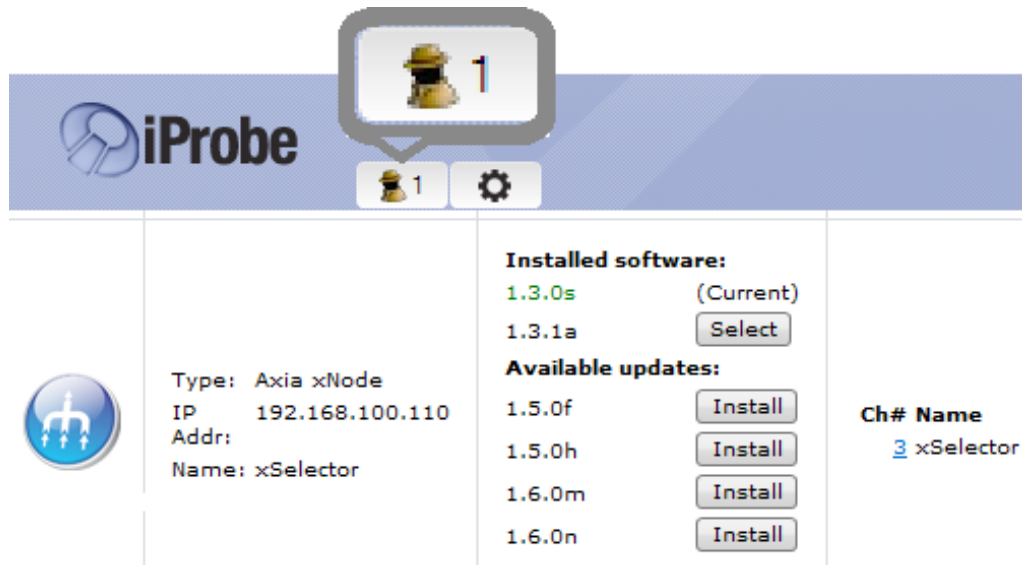

Fig. Q-1: Bootstrap indication in iProbe highlighted for clarity

Configuration options will appear, allowing you to push an IP address, a Subnet mask, and a Configuration to your new xSelector. If you have no backup configuration to send, then apply an IP address and log into the device through the iProbe interface, then configure it per the web interface configuration outlined in Chapter 3 of this manual.

If you'd like to know more about how iProbe works its magic, download the manual from www.AxiaAudio.com.

Fast Operation

You'll find in-depth instructions further on in this manual, but here's a fast overview to get you started.

Front Panel



- **Left Knob:** controls the volume of the adjacent 1/4" Headphone output.
- **Display Screen:** By default, displays meters of Input and selected Output streams.
- **Right Knob:** Rotate to select an audio stream from the Livewire™ network; press to “take”. Audio is automatically fed to rear-panel outputs and front-panel 1/4" jack.
- **Preset Keys:** Use these to quickly recall frequently-used sources. To program:
 - » Choose a stream using the Display Screen and Right Knob.
 - » Press-and-hold one of the Preset keys until it turns yellow.
 - » Release the key; it turns green. The source is now programmed to that key.
 - » Press any Preset key to recall its preset source. It turns green to indicate selection.

Rear Panel



- **Analog and AES/EBU Connections:** You can connect one local input and one local output to xSelector, using XLR or RJ-45 connectors.
 - » Analog and AES/EBU inputs are exclusive. Connecting an AES/EBU input disables the Analog input.
 - » Analog and AES/EBU outputs simultaneously output the audio source selected using the front-panel controls.
- **GPIO Connections.** xSelector has two DB-15 connections for GPIO. Each one has 5 GPI and 5 GPO closures. They can be associated with the audio stream selected using the front-panel controls, or customized to suit your purposes. For setup information, please refer Chapter 3 of this manual.
- **Livewire RJ-45 Ports.** Mirrored ports connect xSelector to your Livewire network.

Chapter One:

Introducing the xSelector

This section will introduce you to xSelector, a networked router selector node with one input and one output.

Streams received by xSelector can be easily selected from a list of available sources using the front panel display screen. Additionally, six frequently-used streams can be assigned to front-panel filmcap buttons for instant access. A headphone jack and volume control round out the front panel.

While xSelector is a handy audio selector when installed in the studio, it can also be a useful piece of test and monitoring equipment in the Technical Operations Center or rack room.

xSelector is also AES67 compatible. AES67 is the standard for audio over IP interoperability approved by the Audio Engineering Society in September 2013. AES67 compliance means that different AoIP formats such as Livewire, Ravenna and others can all work and play well together.

xSelector Features

- Rear panel audio I/O with RJ45 or XLR
 - » 1 Stereo Analog input or AES-3 input (AES data stream presence pre-empts analog input)
 - » 1 Stereo Analog output and 1 AES-3 digital audio output (simultaneous)
- 1 Headphone output (mirrors selected audio output)
- Volume control for headphone and rear output (selectable)
- 2 GPIO ports, each with five opto-isolated inputs and five opto-isolated outputs
- OLED display for source selection, metering, GPIO status, and setup
- Dual mirroring redundant 100BT Ethernet ports or secondary management port
- Thermal sensor for over temperature status
- IEEE 1588 synchronization support
- Ravenna stream routing support
- AES-67 compatible

Front Panel Controls & Indicators



Fig. 1-1: xSelector front panel

xSelector's front panel has a number of controls that make it fast and easy for operators to quickly select audio sources from the network for local playback:

OLED Display and Control Knob: The display and adjacent rotary encoder perform multiple functions including:

- I/O Level meters (this is the default view),
- Selection of available audio streams from a scrolling list,
- The one-minute fast setup routine,
- Other settings.

Fast Select Keys: The six film-cap keys select stored sources which are routed to the output (destination) of the device. These work in a similar fashion to the preset buttons on a car radio. When pressed, the keys glow green to indicate selection. Keys may be labeled by laser-printing on standard transparency films and inserting them behind the button caps, or with transparent adhesive labels if you wish.

Headphone Jack and Volume Control: On the far left of the front panel is a 1/4-inch TRS headphone jack with adjacent volume control.

Rear Panel Connections



Fig. 1-2: xSelector rear panel

The rear panel of the xSelector has both XLR connectors, and RJ-45 connectors which follow the StudioHub+ standard for audio I/O.

| LINE and AES INPUT CONNECTIONS (RJ-45) | |
|--|-----------------------------------|
| Pin | Function: Analog/AES |
| 1 | Analog Left Channel Input + /AES+ |
| 2 | Analog Left Channel Input - /AES- |
| 3 | Analog Right Channel Input + |
| 4 | Ground |
| 5 | Not Used |
| 6 | Analog Right Channel Input - |
| 7 | Not Used |
| 8 | Not Used |

| INPUT CONNECTORS (XLR-F) | |
|--------------------------|-----------------------|
| Pin | Function: Analog/AES |
| 1 | Ground |
| 2 | Balanced Input +/AES+ |
| 3 | Balanced Input -/AES- |



Fig. 1-3: Analog I/O connections

The Analog I/O section is on the far left side. There are two XLR-F connectors for Left/Right input, which are electrically in parallel with the top RJ45 positioned to their immediate right.

Just beneath it is another RJ45, which is the unit's Analog output. This is electrically in parallel with two XLR-M connectors to its right.

NOTE: Axia recommends using balanced audio for analog audio connections. If unbalanced sources are to be connected to these inputs, we strongly recommend using a balun (transformer) or balanced-to-unbalanced buffer amplifier at the source device. Such devices are readily available, for example the StudioHub "Match Jack".

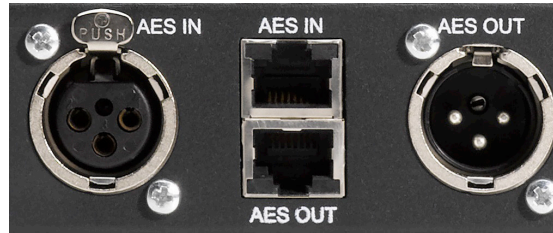

Fig. 1-4: AES/EBU I/O connections

In the center section, you'll find connections for AES-3 digital audio. There is a single XLR-F for digital audio in, and a single XLR-M for digital audio out. Between the two XLR connectors are two RJ45 ports for digital audio in and out, again following the StudioHub+ standard.

NOTE: The xSelector will automatically switch between analog and AES inputs; if a valid AES input signal is present, this will be used, otherwise the analog input will be used.



Fig. 1-5: GPIO and Livewire network connections

xSelector has two GPIO ports. Each has five opto-isolated inputs and five opto-isolated outputs. The pinout for the GPIO's DA-15 connectors is as follows:

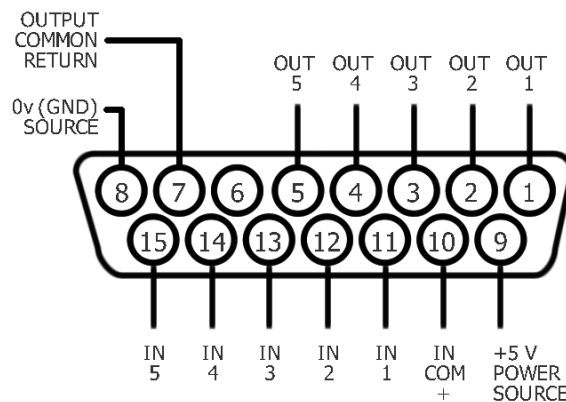

Next to the two GPIO ports are two RJ45 ports for connections to the Axia network. Default operation of the ports is mirroring redundancy, but the ports can be configured as one Livewire port and a second management port, for connection to another network.

Finally, to the far right of the rear panel is a standard IEC connection for AC power. The power supply has a “universal” AC input, accepting a range from 90 to 240 VAC, 50-60 Hz. A fuse is located inside on the power supply circuit board.

IMPORTANT! As with any piece of modern electronic gear, it is advisable that precautions be taken to prevent damage caused by power surges. Standard line surge protectors can be used to offer some degree of protection. It is the user’s responsibility to ensure protection adequate for their conditions is provided. This equipment is designed to be operated from a power source which includes a third “grounding” connection in addition to the power leads. Do not defeat this safety feature. In addition to creating a potentially hazardous situation, defeating this safety ground will prevent the internal line noise filter from functioning.

Web Interface

xSelector options, like other Axia products, can be accessed via its internal Web server. This server provides status information, as well as basic and advanced configuration options.

xSelector is designed so that the user can do basic configuration or change a route to the xSelector from the front panel. From the web interface one can also change a route, and additionally, configure GPIO ports, check meters, and change advanced settings.

There are times when xSelector’s front panel is the quickest way to do what you want, other times when a Web browser is necessary. The Web server also enables remote access for those times when you’re not physically close to the unit.

xSelector’s web server also breaks the old bugaboo about PC vs Mac. With a web browser, any Mac on the network can get you into your web-enabled Axia gear.

What’s Next?

So, there’s your nickel tour of xSelector. If you followed the Quickstart at the front of the manual, you learned how to set up your unit and get it running fast; in Chapter 2, we’ll take a more in-depth look at its operation.

*Do digital streams
dream of electric DJs?
Just Bradbury knows.*

Chapter Two:

Using xSelector

xSelector is designed primarily so that operators can choose sources from the Livewire network, which are sent to the unit's audio output. Most, if not all, of these operations are done using the controls provided on the unit's front panel. This chapter will get you familiar with these controls.

Power Up!

Although xSelector has a built-in web server for configuration and administration, you can get xSelector connected to your network using just front-panel controls (See the Quickstart preface to this manual for instructions on how to do this). Some users will prefer to assign an IP address using the front panel controls, and then perform the rest of the configuration from the node's web pages; we'll cover Advanced Programming in Chapter Three.

As soon as you plug xSelector in, it performs a short power-on self test. Once booted, the LED to the right of the selector knob will turn from red to green. The OLED display illuminates and you'll see the default screen showing the meters.

Basic Operation

Operating xSelector from the front panel is quite simple. Streams can be selected, assigned to an instant access filmcap button if desired, and the headphone/ output volume may be adjusted.

Selecting a Stream to Record, Store or Play

From the default menu screen click the control knob once. The source selection screen, shown below, will be displayed.

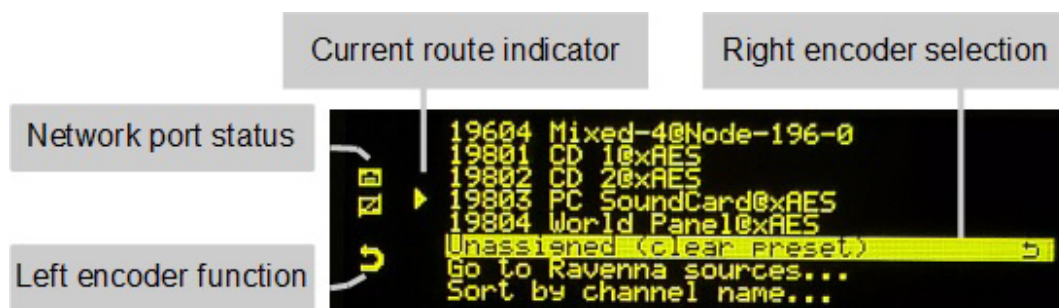

Fig. 2-1: Source selection page.

The OLED display works with the adjacent knob. By default, the display shows the meters for input and output. Rotating the knob changes the display, showing sources available for selection.

To select a source to route to xSelector’s outputs, rotate the knob to highlight the desired source, then press the knob to “take” that source. That’s it!

Streams can be displayed in order by their Livewire channel number, or by their name. To change the sort criteria, rotate the knob clockwise until you reach the end of the source list. You can now highlight and select from the following options:

- **Unassigned (clear preset):** This option provides the ability to clear the source assigned to any of the six front-panel Preset keys. To do this, highlight the option and *press and hold* the selection knob. *While holding, press and hold* the preset button you wish to clear. When the button turns yellow, its preset has been cleared.
- **Go to RAVENNA sources...:** Selecting this option filters the list to display only RAVENNA sources advertised on the network. At the bottom of the Ravenna listing is an option to **Go to Livewire sources...** which returns you to a listing of Livewire sources.
- **Sort by channel name...:** By default, xSelector shows sources in order of their Livewire channel number. Selecting this option organizes the source listing by name instead. The channel number will still be shown, but the order of sources is now based on the alphabetical order of names.

NOTE: At the top of the list, you’ll see “(no audio)” . Highlight and select this in order to clear your selection and mute the outputs.

While in the Source Selection screen, you’ll find a “Return” icon to the bottom left (as shown in Figure 2.1). This informs you of the function assigned to the left-most front-panel control knob (the Headphone Volume Control knob). While in the Source Selection view, pressing this knob will return the screen to the meter view. (The screen will also return automatically to the meter view if you do nothing for 30 seconds.)

Programming And Using the Fast Selection keys

The xSelector has six preset buttons on the front panel for frequently-used sources. To program:

- **Selecting the source** as outlined above.
- **Press and hold** the key you want to assign the source to, until it illuminates yellow.
- **Release the key.** The key’s illumination turns from yellow to green, indicating that the key is programmed and the source is selected.

To instantly recall a stream assigned to a key, just press that key. It will illuminate green and the audio will be routed to the unit’s outputs.

You can label these keys for easy reference, if you like, by laser-printing on standard transparency films and inserting the cut squares behind the keycaps (pry gently to remove), or by using an adhesive-film labeler such as a P-Touch or other label-strip printing device.

Adjusting Output Volume

Whenever the unit displays its default screen (output meters shown), the headphone volume may be adjusted by rotating its adjacent control knob. By default, this adjusts the front-panel headphone levels only; the line level outputs on the rear panel are not affected unless the front panel level control has been configured for **Ph&Out** (headphones and output) as described later in this section.

Advanced Operation

This section details how to changed advanced settings using xSelector's front-panel controls.

The knob used for source selection is also used to change the OLED display to different Page views. While output meters are displayed, **depressing the knob** will advance through the GPIO, Node ID, IP Address, and xSelector title pages.

GPIO Page

The GPIO page displays a representation of the two GPIO ports on the back of the xSelector.

- The five boxes on the top rows represent the five logic Inputs of the ports.
- The five boxes on the bottom rows represent the five logic Outputs of the ports.



Fig. 2-2: GPIO Status page.

As the logic pins change state, the boxes' display changes, too: an active-low condition is represented by a solid box.

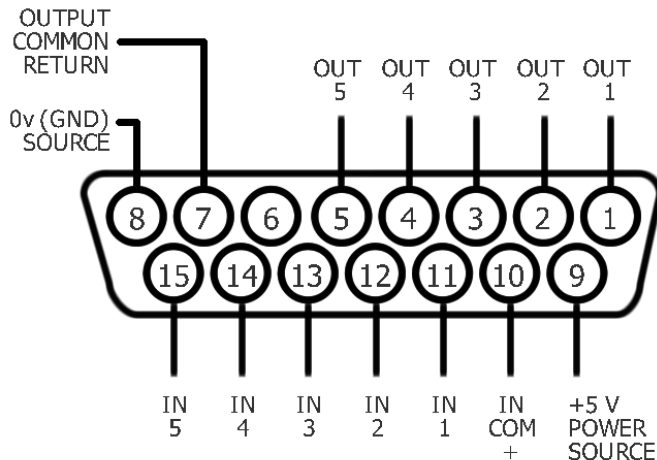

Fig. 2-3: GPIO port pinouts.

The icon at the top-right of the screen indicates the function associated with a press of the knob adjacent to the screen (advance to next page). Press it to go to the Node ID page.

Node ID Page

This page is used to set up xSelector using the front-panel controls.

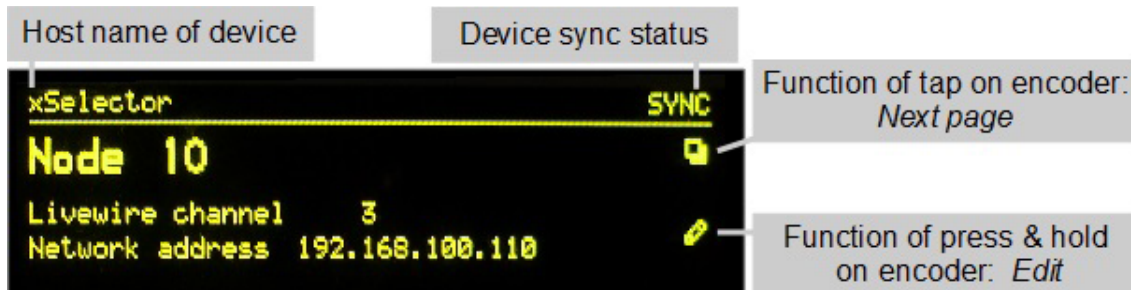

Fig. 2-4: Node ID page.

On the right side of the page are two icons.

- The top icon (two boxes) represents the page change function triggered by a tap of the encoder (advance to next page).
- The bottom icon is a pencil indicating there's an "edit" function for this page; **press and hold** the encoder knob for 10 seconds to enter Edit mode and change settings.

This page is intended for fast automatic setup as discussed in the Quickstart preface to this manual. For general use, the page shows the Node ID, the Livewire channel number of the source created by the xSelector, and the IP address of the device.

IP Address Page

This page item is similar to the Node ID page. It's primarily for manual setup if preferred.

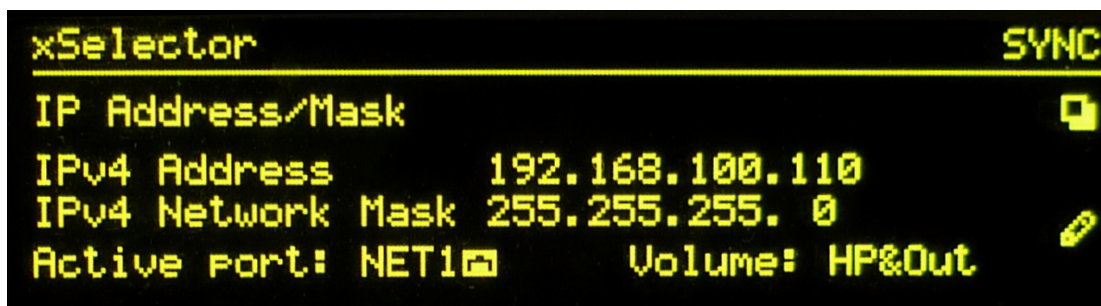

Fig. 2-4: IP Address page.

On the right side of the screen are, again, the two icons.

- The top icon (two boxes) represents the page change function triggered by a tap of the encoder (advance to next page).
- The bottom pencil icon denotes an “edit” function for this page; **press and hold** the encoder knob for 10 seconds to enter Edit mode.

From the Edit view, the user can edit several settings.

- Once in Edit view, you’ll see a cursor under the IP Address digits. Rotate the encoder knob to change the value of the digit; press the encoder to move to the next digit.
- Move through the Network Mask field in the same way to make changes.
- The next option allows you to select the active Livewire port manually; useful if the dual ports are configured for Failover operation.
- The last option from this menu is the “Volume” selection:
 - » Choose “Phones” if you only want the front-panel Volume knob to control the headphone-jack output.
 - » Choose “HP&Out” for the Volume knob to control the output of both the headphone jack and rear-panel outputs.

Title Page

This page provides some system information. At bottom right is a device temperature readout; bottom left shows the current software version.



Fig. 2-5: Title page.

At the screen's top left is the **ID** icon. Pressing the control knob on the left of the front-panel issues a BOOTP request to the network, used with Axia iProbe software for configuration assistance.

The top right again shows the Page icon. Pressing the right knob returns the display to the Meters page.

Meters Page

Two sets of meters are provided on the Meters page.

- The left-most set of meters indicates the peak levels of audio fed to the xSelector's rear-panel inputs. (A tally at the bottom of the screen indicates whether the unit's Analog or AES/EBU inputs are the active source.)

NOTE: If there is signal detected on the digital input, this input is used. If no digital signal is detected, the xSelector defaults to the analog input.

- The right-most set of meters indicates the peak levels of the xSelector's outputs; that is, the level of the audio source you've selected from the Livewire network. (Another tally at screen bottom tells you the Livewire Channel number and name of the selected network source).

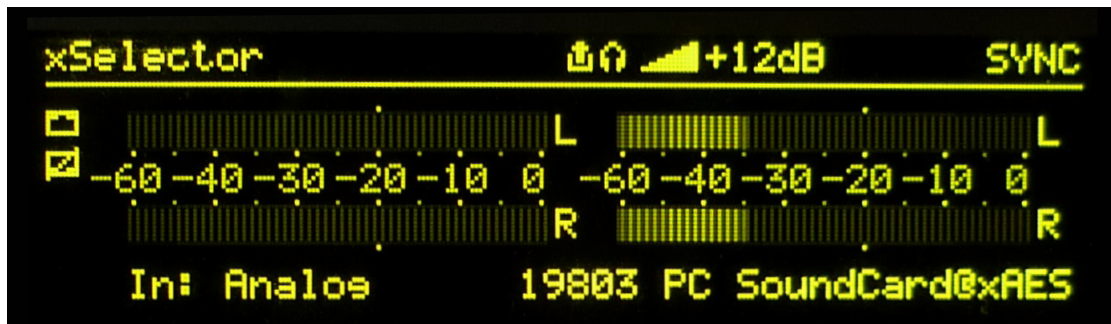

Fig. 2-6: Meters page.

At the top of the display window is a volume indicator, which shows the user the volume of the headphone output (or of the headphone and rear outputs, if configured for this function). The level is indicated in dB values. A value of 0dB is unity (no gain adjustment of the selected source). The icons to the left of this value indicate whether the volume control knob affects only the front-panel headphone jack, or the rear-panel outputs as well.

Also on the Meters page, you'll see the device name given to the xSelector (set from the System web page; see Chapter 3 for details).

Text on the far right indicates the status of device synchronization.

- **A blinking SYNC indication** means that the device is synchronizing its own clock to correspond with the network master clock. At bootup, SYNC blinks until network synchronization is achieved. Once synched, the device should display...
- **A solid SYNC indication** shows that the device is synchronized to the network clock.
- **A MASTER indication** shows the device is acting a source of clock to the rest of the Livewire network. (More information on synchronization is covered in Chapter 3, in the section detailing the Home web page.

When xSelector's controls are not adjusted for a period of 60 seconds, the OLED automatically dims to extend the life of the display. Touching any control brings the display back to full brightness.

What's Next?

You've learned how to select audio sources, assign your most popular sources to the six Fast Access keys, and learned about the xSelector's different display pages. We've gone about as far as we can using only front-panel controls, so in Chapter 3, we'll use xSelector's Web server to take you through a tour of the advanced options available.

To and fro bits flow

Audio anywhere now

Fingertips decide.

Chapter 3:

In Depth / Advanced Programming

xSelector is equipped with an internal HTML server so you can access its “web pages” from any browser on a computer attached to your network. These pages are used to configure, control, and retrieve status from the device. This chapter will give an in-depth tour of the xSelector HTML pages.

Accessing xSelector’s Web Pages

To access the web server from a computer, the computer and xSelector must be connected to the same LAN. Alternately, you can connect the computer to xSelector by using a “crossover 10/100 Base-T” Ethernet cable.

To connect, open your Web browser and enter the IP address of the xSelector. (The IP address is shown on the unit’s OLED display in the Node ID and IP Address pages — simply press the knob adjacent to the display until you reach one of these screens). After entering the IP address, your browser will display the xSelector’s Home page, with links to the various functions available.

NOTE: We assume you know the basics of network architecture, but we must mention that the first three numbers of the IP address of the computer you are using will normally match those of the device you are attempting to configure; i.e., 192.168.15.xxx. If they don’t, the gear won’t be able to communicate and you’ll just get frustrated.

Login/Password

When you access the Home page of your xSelector, you’ll be prompted for a login and password.

- The factory-default **user name** for all Axia gear is *user*.
- Leave the **password** field blank, and click *OK*.

Once you have successfully logged in, you may access any of the node’s web pages. (You can change the login and password once logged into the unit, if you wish.)

The xSelector Home Page

The home page simply acts as a “jumping off” point to access the configuration pages. The home page contains the following information:

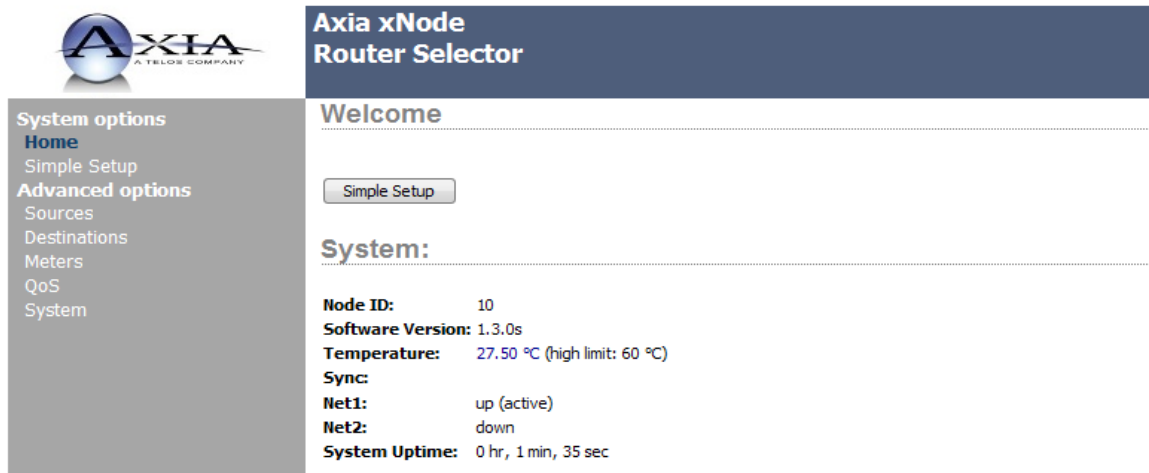

The screenshot shows the Axia xNode Router Selector interface. On the left is a navigation menu with 'System options' and 'Advanced options' sections. The 'Home' link is highlighted. A 'Simple Setup' button is visible. The 'System:' section displays the following information:

| | |
|--------------------------|------------------------------|
| Node ID: | 10 |
| Software Version: | 1.3.0s |
| Temperature: | 27.50 °C (high limit: 60 °C) |
| Sync: | |
| Net1: | up (active) |
| Net2: | down |
| System Uptime: | 0 hr, 1 min, 35 sec |

Fig. 3-1: xSelector Home page

- **Node ID** (shown if ID assigned): xSelector can be assigned an ID number which is used to assist with Simple Setup IP addressing and channel numbering.
- **Software Version:** The software version currently running on the xSelector.
- **Temperature:** The temperature reading of the internal sensor. Alarm status will appear if the temperature is above acceptable limits.
- **Sync:** A solid SYNC indication represents synchronization with the network clock-sync source. Under the SYNC indication, a calculated ID value of the master clock is displayed; the IP address or MAC value of the source of clock (depending on software version).
 - » After the address is a **p#** indication, showing the priority setting of the master. The numbers that follow are health indicators of the sync.
 - » The lower-case Delta indicates phase error between local time and recovered clock.
 - » The lower-case Sigma indicates variations in the delta. The values of delta and sigma are expected to be below +/- 1.0 micro seconds.
 - » Frequency Adjustment indicates adjustments made to local clock in order to match recovered network time. Accepted value is to be within +/- 5.0 ppm.

- **Net1 and Net2:** Shows the status of the xSelector’s Ethernet ports and indicates which port is active.
- **System Uptime:** The amount of time elapsed since the last power cycle.
- **Simple Setup:** This button links to the Simple Setup page.

Simple Setup Page

Simple Setup contains basic configuration options, assuming that you have utilized the ID setup procedure as explained in this manual’s Quickstart guide.

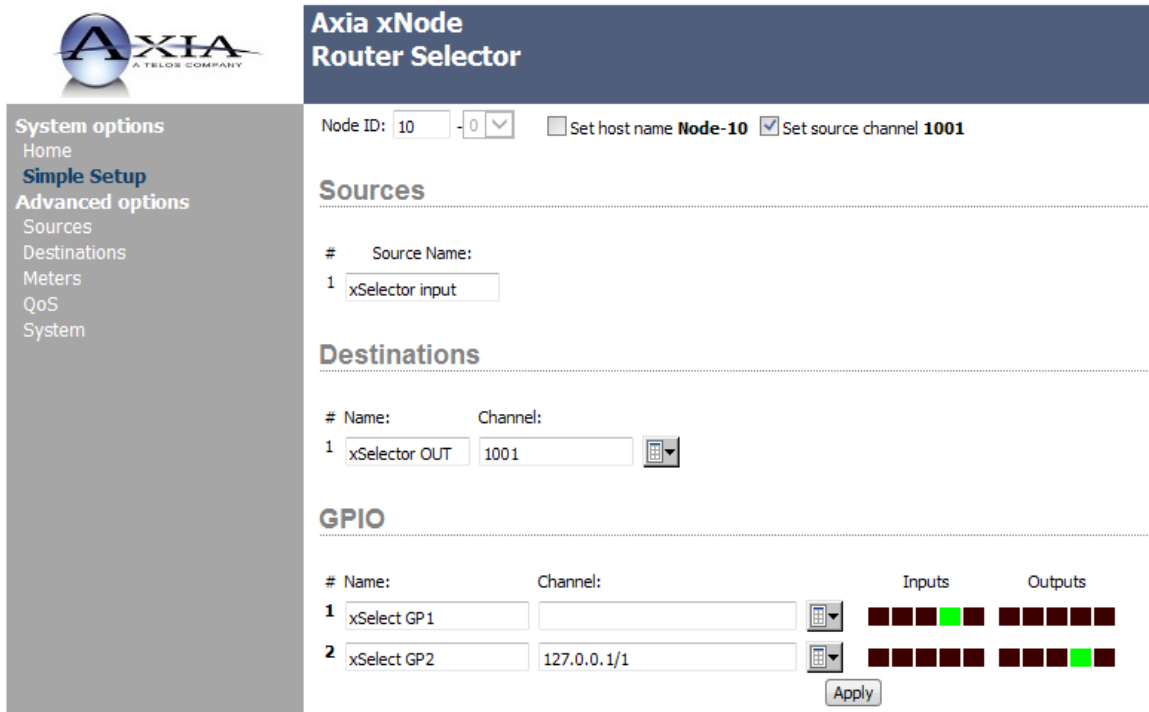

Fig. 3-2: Simple Setup page

- **Node ID:** allows you to change the numerical value of the Node ID from the web interface, and also decide whether the Node ID value will define the Host Name of the device, and its Source Channel number. By default, the Node ID determines the IP Address of the unit, and the Source Channel number of the audio source its rear-panel input sends to the Livewire network.

For instance: Node ID Numbers (*nn*) in the 1 - 99 range support small-to-medium networks with up to 99 devices. The Node ID assigns the IP Address so: (10.216.0.1*nn*) and the source Channel Numbers so: (*nn*01-*nn*08).

Node ID Numbers (*abc*) in the 100-319 range support large networks with up to 2299 nodes. When a 3-digit Node ID is given, a second-level identifier becomes available with range of (*d*)=<0-9>. This larger Node ID number results in an assigned IP Address so: (10.216.*ab*.1*cd*) and the source Channel Numbers so: (*abcd*1-*abcd*8).

- **Set Host Name / Set Source Channel:** These checkboxes allow you to choose whether the values autocalculated from the Node ID are used or not. Leave them checked to use them; clear them to set these values manually.
- **Source Name:** Here, you can manually name the audio input of your xSelector, and it will be known through the network by the name given in this field. Good naming practices can help users quickly identify sources when searching the network. For example, *D07S12* is not helpful to the user who's attempting to locate the audio mix from a news room. The name *NewsRoomA* would be a friendlier choice!
- **Destination Name:** xSelector's front panel allows users to change the audio source that's routed to the unit's output. In Livewire parlance, outputs (where sources are routed to) are called *Destinations*. Defining a user-friendly name helps you in two ways. One, when you log into this device many months after install, you can refer to the destination name to recall what is wired to the output.

Two other applications, for example: Remote-control software may use this name to identify the output. So a Name of "Newsroom Router", "Aux Select", or some such name related to the device's function within your plant would be appropriate. The field may contain 16 characters or less.

- **Destination Channel:** Following the Name field is the Channel field. The Channel number represents the source to be routed to the destination. If you don't know the number of the source to be routed, you can press the **Browse** button immediately to the right of the text field. This opens a pop-up, which lists all the sources available on your network. They are hyperlinked, allowing you to easily choose one by clicking on its name.
- **GPIO Name and GPIO Channel:** The xSelector has two GPIO ports, represented by the two graphical rows shown in this section. The first item is the Name field, which is used to identify how this resource is being used. The next text field is referred to as the Channel field. The Channel field is where the port can be assigned a function. There are three different ways in which a GPIO port can be used:
 - » **Port routing.** In this state, the General Purpose Outputs (GPOs) of the local port will mimic the General Purpose Inputs (GPIs) of the remote port (routing GPI logic to GPO logic). This is accomplished by entering in the IP address of the remote device with the GPIO port you wish to mimic locally, followed by a Forward Slash, and then the port number of that remote port.

For example, *10.216.0.121/5* would be Port 5 from the device located at IP Address 10.216.0.121, and which supports GPIO. As a test, you could also set Port 1 of the xSelector to *127.0.0.1/1* (127.0.0.1 is known as a loopback address). This will cause the GPOs of the first port to mimic the GPIs of the same port.
 - » **Channel assignment.** This option assigns the local port to follow the logic associated with a selected audio source; that is, the logic associated with an audio source, as defined by a console — the GPIO commands to start and stop DAT deck, for instance, which are associated with that deck's audio stream.

To assign a port to a audio channel, either manually enter in the numerical value or use the Browse button to search the network for advertised sources.

NOTE: Appendix A covers common pre-defined functions established by Axia consoles.

- » **Pathfinder control.** The Axia Pathfinder series of routing automation products have the ability to observe GPIO activity, as well as trigger GPO activity. No xSelector configuration is necessary to support this method — all configuration is done using the tools found in Pathfinder. Please review your Pathfinder documentation for detailed instructions.

To the right of the channel fields are groups of squares which represent the inputs and outputs. When a GPIO is in the high state, the square will be black in color. A square in green represents the pin is active-low. (Note that this is simply a graphical representation of a pin's state, and is not used to control the states.) Changes made here will take place after clicking the Apply button.

Advanced Options Screens

While you've already defined the properties for GPIO, sources and destinations, more advanced features such as AES 67 implementation and multicasting are available under the advanced options menu. Other parameters included here include: meters, Quality of Service (QoS), synchronization and live audio/clock streams.

Advanced Options – Sources

The advanced option for sources lets you configure source details more finely than the Simple Setup does.

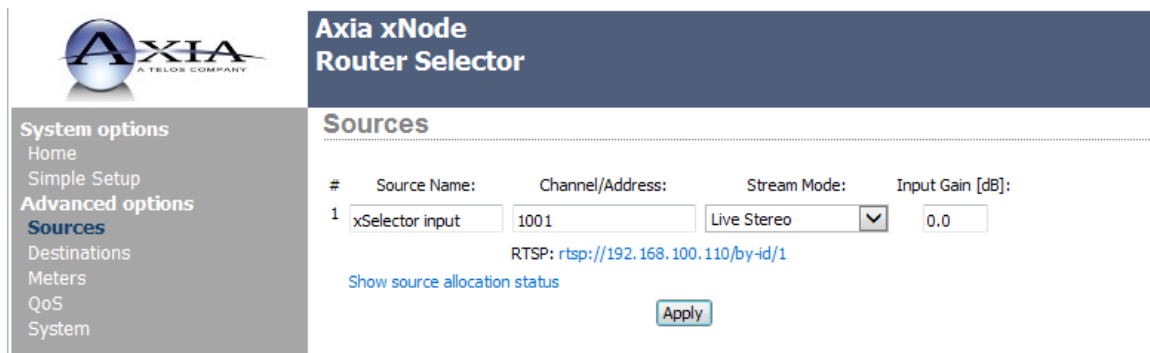

Fig. 3-3: Advanced Options – Sources page

- **Source Name:** This is the same property described in Simple Setup. The source name will be displayed on other devices in your Livewire network to identify the source supplied by the audio inputs of your xSelector.
- **Channel/Address:** The channel number is a numerical value from 1 to 32,767. This number is used to define the multicast address used for the data stream that carries the device's audio. xSelector also allows for entering an address directly, for future AES67 implementations; for Livewire installations, simply enter a numerical value that fits within your facility's channel numbering schema.

- **Stream Mode:** The drop down provides 4 options:
 - » **Live Stereo** is a low latency stream intended for monitoring of “live” audio.
 - » **Low Latency Stereo** is a stream option that supports RAVENNA functionality.
 - » **Standard Stereo** is suitable for sources that don’t need to monitor their own audio (for example, CD players or satellite downlinks).
 - » **Disable** turns off xSelector’s local inputs and sends no stream to the network.

NOTE: Live streams provide low audio latency with a round-trip delay of 2ms. Each packet takes 154 bytes, 12 samples, or 250 microseconds of audio, on the wire where packets are sent at 4000 packets/s. Each Live stream requires 4.9Mbits/s bandwidth.

Standard Streams provide higher network utilization efficiency. Standard Stream latency depends on the buffer allocation in the receiving device; typical buffer setting in an xSelector is 20ms. Each packet takes 1522 bytes on the wire (maximum allowed Ethernet frame size), at 200 packets/s. Each stream requires 2.5Mbits/s bandwidth.

Low Latency mode supports other standards such as RAVENNA and AES67. This is a packet containing 48 samples, or 1ms., of audio.

- **Input Gain:** Allows adjustment of the input gain from -72dB to 24dB. This gain adjustment takes place *after* the A-to-D conversion.
- **RTSP: (Real Time Streaming Protocol):** Clicking this link plays the audio stream in any player or device that can play the audio format. This is included for support of RAVENNA and other network audio receivers; it’s not used or needed for Livewire devices.
- **Show source allocation status:** Clicking this link opens a pop-up that allows you to see if the source is loaded to a mixing console that’s part of the Livewire network. Behind the scenes, Livewire keeps track of “source allocation”, or ownership of a source. This information is used by Axia consoles to help control things such as logic, mix-minus (backfeeds), and headphone feeds. This pop-up view can tell you whether xSelector’s output stream is loaded to a console fader.

Advanced Options – Destinations

The advanced option for Destinations lets you configure details more finely than the Simple Setup does.

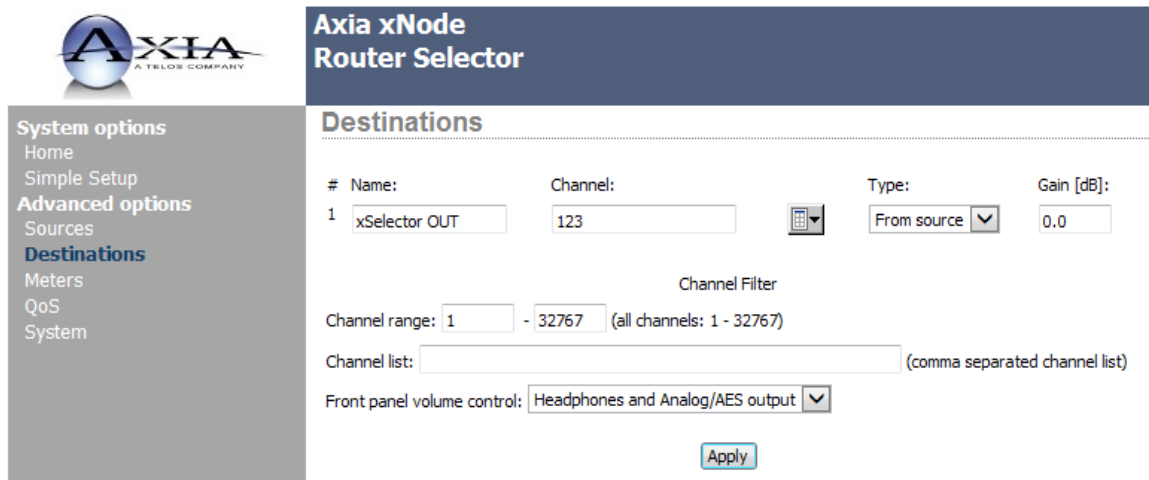

The screenshot shows the 'Axia xNode Router Selector' interface. On the left is a navigation menu with 'Destinations' highlighted. The main area is titled 'Destinations' and contains a table with one entry: # 1, Name: xSelector OUT, Channel: 123, Type: From source, Gain [dB]: 0.0. Below the table are fields for 'Channel range' (1 - 32767), 'Channel list', and 'Front panel volume control' (Headphones and Analog/AES output). An 'Apply' button is at the bottom.

Fig. 3-4: Advanced Options – Destinations page

- **Name:** The same property as in Simple Setup. It's used to identify the device's local output to the viewer of the configuration screen, or to third-party control systems, which can use it to populate their user interface.
- **Channel:** The field is used to assign an audio source to the destination. Since xSelector's primary function is to output sources selected via the front panel, this field can be left blank at installation.

If you do enter a Channel number in this field, however, that channel's audio will be routed to the xSelector's outputs, so you can use this for remote control of the device if no one is present in person to operate the front panel!

To the right of the text field is the Browse button, which opens a pop-up window listing sources available on the network. Selecting one from the pop-up closes the pop-up and auto-populates the source's information in the Channel field.

- **Type:** The options available here cover two different Livewire types, plus RAVENNA and Other, in anticipation AES67 interoperation. For Livewire types there are "From Source" and "To Source". If you are browsing the network source list, the item you select will automatically select the "To Source" or "From Source" for you. Only modify this option if you wish to manually select the stream type.

NOTE: What's this all about? Axia consoles create on-demand sources like headphone feeds, or mix-minuses for Phones and Codecs. We call these on-demand sources "backfeeds." Backfeeds are selected by selecting "To Source". Most sources on the network will be "From source".

- **Gain:** This adjusts the xSelector's output level. Adjustment range is from -72.0 to 24.0 dB.
- **Channel Range:** This allows you to filter, by number, the channels which may be displayed in the source list on the xSelector's OLED display. By default, the values are the full range of Livewire channel numbers, from 1 – 32767. A lower and upper limit can be entered to limit the allowed range of channels.
- **Channel List:** A more granular filter option than the Channel Range filter above. This permits you to explicitly define what channels are displayed on the front panel OLED, using comma separation and dash ranges, which may be mixed. For example, you could enter this string: *1201, 1301, 1401, 2001-2020* — to allow only the first three channels, plus the range called out afterward, to be displayed on the front panel.
- **Front Panel Volume Control:** xSelector provides a Volume knob on the left side, which by default control only the volume of the front-panel headphone jack. This drop gives you the option for the Volume knob to control, in parallel, both the Headphone and the rear-panel audio outputs. This is useful if the xSelector is used to drive speakers.

Advanced Options – Meters Page

The Meters page is common to the xNode family of AoIP adapters:

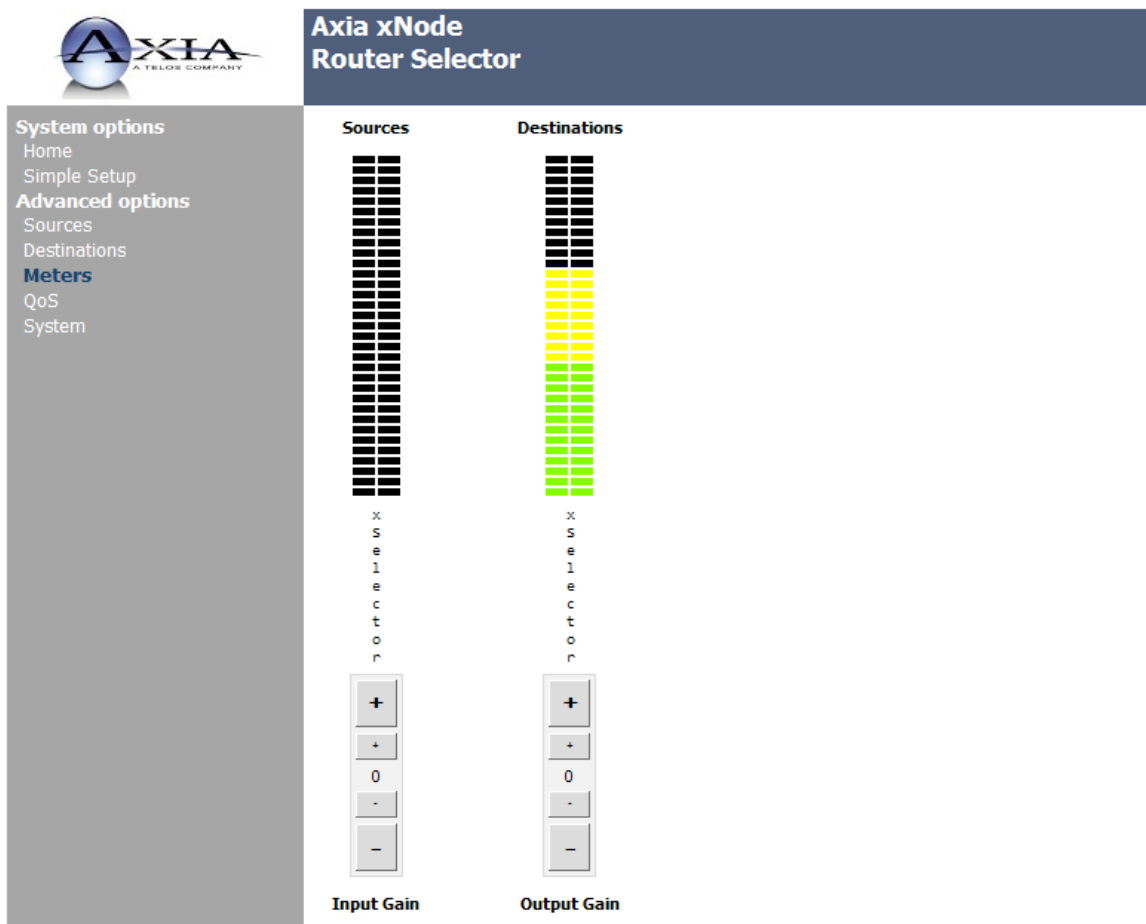

Fig. 3-5: Advanced Options – Meters page

In addition to metering the input and output levels of the xSelector, clicking the buttons below each meter allows you to fine-tune the Source and Destination gain settings.

- **Clicking the large +/-** changes the gain by 1dB.
- **Clicking the small +/-** changes the gain by 0.1dB.

QoS Page

We're into the Deep Tech now! The QoS page has three sections: "Synchronization", "Live Audio/Clock Streams", and "Standard Audio Streams." The majority of these items are optimized for a Livewire network, and adjustments are not needed. In special cases, however, you may need to change these settings from their default values.

Axia xNode Router Selector

System options
Home
Simple Setup
Advanced options
Sources
Destinations
Meters
QoS
System

Synchronization:

Clock mode: Livewire IP low rate (default) ▼

Livewire clock master priority: 3 (default) ▼

PTP domain number: 0 default ▼

PTP delay mechanism: EZE - uses the end-to-end delay request-response (default) ▼

PTP clock priority 1/priority2: 128 ▼ / 128 ▼

PTP clock sync interval: 0 (1s) - PTP Default profile (default) ▼

AES sync source: Livewire 48kHz ▼

AES output sync: Livewire 48kHz ▼

AES sync source as Livewire master timebase: no ▼

AES mute on LW stream fail: no ▼

Live Audio / Clock Streams:

802.1Q tagging: Enabled ▼

802.1Q VLAN ID: 0

802.1p priority: 6 (default) ▼

DSCP Class of Service: 48 CS6 (default) ▼

Standard Audio Streams:

Receive buffer size [ms] (default 20): 20 (15 - 100)

802.1Q tagging: Disabled ▼

802.1Q VLAN ID: 0

802.1p priority: 5 (default) ▼

DSCP Class of Service: 46 Expedited Forwarding (default) ▼

Apply

Fig. 3-6: Advanced Options – QoS page

Synchronization

Livewire's clocking system is automatic and largely transparent to end users. If no clock is present on the network, Axia devices automatically negotiate a master based on priority settings and the lowest MAC address. The following options may be used to modify clocking, but we strongly suggest you leave them at default values unless instructed otherwise by an Axia Support expert.

- **Clock mode:**
 - » **Livewire IP Low Rate** (the default setting) is suggested for a typical Livewire network. Livewire IP "STL" is for applications where a node is at the remote end of an STL link (Livestreams are not supported while in this mode).
 - » **Livewire IP High Rate** tasks the xNode to synchronize to the fast clock, and is not needed in most cases.
 - » **Livewire Ethernet** is a legacy sync method available for any customers still running superceded systems.
 - » **PTP/ IEEE 1588 ARB Clock Class 248** enables the xNode to participate in the execution of the best master clock algorithm for a PTP (Precision Time Protocol) network (enabling it to be a master PTP clock).
 - » **PTP/IEEE 1588 Slave** enables the xNode to synchronize to a PTP network.
 - » **NTP Slave** is used for special applications that synchronize from an NTP source (Livestreams not supported within NTP mode).
- **Livewire Clock Master Priority:** In a Livewire network, higher priority is given to nodes with a higher numerical priority setting. A value of "0" will never generate clock; a value of "7" will always generate clock. Values between will generate clock if no clock is received from another device, and the system will elect a master source based on priority settings.

7 (Always master) "STL snake" is used in cases where the xNode is at one end of a wireless link. This mode will cause the node to generate clock and will suppress the generation of fast clock.

3 (default priority) allows any device to become a source of clock, with equal priority.

The following items are settings used with PTP (IEEE1588) synchronization:

- **PTP Domain Number:** A domain is one or more PTP devices communicating with each other. A domain association is used to define communication messages. A value of 0 is standard; values to 127 may be selected.
- **PTP Delay Mechanism:** Values of PTP or E2E may be selected.
 - » **PTP** supports two methods of time correction which alter messaging between devices. All devices within the network should use the same mechanism.
 - » **E2E** (End-to-End) is the default and recommended setting, since more networked devices prefer to support this option.
- **PTP Clock Priority1/Priority2:** Priority setting from 0-255 is used in the Best Master Clock algorithm (BMC) to determine a Grandmaster. Lower numbers have higher priority.
- **PTP Clock Sync Interval:** This specifies the time interval used for sending synchronization messages.
 - » A setting of **-4** equals 16 messages in 1 second.
 - » A setting of **1** equals 1 message in 2 seconds.
 - » The default setting is **0**, 1 message per second.

The following items are AES (digital audio) settings available for xSelector:

- **AES Sync Source:** Two options are available to define the sample rate of xSelector's AES output: **Livewire**, at 48kHz, and **Sync From AES Input**, which allows you to supply an alternate clock rate from an external source. If Sync From AES Input is chosen and no input signal is available, sync defaults back to Livewire.
- **AES Output Sync:** If you wish to set the AES output to a different clock rate, the AES Sync Source (above) should be set to Sync From AES Input, and this option should be set to **AES Sync Source**.
- **AES Sync Source As Livewire Master Timebase:** In almost all cases this option should be set to **No**. If you wish to sync the Livewire network to an external clock source, set this to **Yes**.
- **AES Mute On LW Stream Fail:** Choosing **YES** turns off the xSelector's AES outputs if there is no received network source. The default **NO** selection supplies a digital stream even if no audio is present.

Live Audio/Clock Streams

These options should remain at default settings unless the network must be customized to operate in a manner different than that of normal Axia operation. Changing these settings requires an in-depth understanding of network QoS packet tagging.

- **802.1Q tagging:** Live audio streams by default are tagged (enabled) in order to take advantage of QoS settings in the switch for priority processing.
- **802.1Q VLAN ID:** 802.1Q tagging includes VLAN value, and the value is shown as 0 for status only. The value of 0 is a placeholder in the packet for the purpose of priority tagging. Actual VLAN values will be associated with another tag if the switch is configured to do so.
- **802.1p priority:** The value of 6 is the value required for Livewire networks per our recommended configuration guidelines.
- **DSCP Class of Service:** The value of 48 is value required for Livewire networks per our recommended configuration guidelines.

Standard Audio Streams

- **Receive Buffer Size [ms]:** The buffer value assigned to the device for reception of standard streams. The value here will delay the time for standard audio streams, but assists with jitter in network reception.

The remainder of the items here are QoS settings for Standard streams, and function as described for Live Audio (above). Due to the device buffer settings for Standard streams, QoS priority settings for these streams are typically not required.

Advanced Options – System page

The System page allows customization of xSelector settings that do not pertain to audio network settings, such as SNMP, Syslog, authentication password, and firmware control settings.

Axia xNode Router Selector

System options
Home
Simple Setup
Advanced options
Sources
Destinations
Meters
QoS
System

IP settings:

Host name: (1-12 characters: letters, numbers, hyphen)

NET1 Network address: mask

NET2 Network address: mask (Default: 0.0.0.0 - NET1 failover)

Gateway:

Livewire enabled ports:

NTP server:

System location:

System contact:

SNMPv1/2c community name: (empty - SNMPv1/2c disabled)

Syslog server (IP address):

Syslog severity level filter:

User password:

New password: (5-8 characters: letters and numbers)

Retype new password: (verify)

Firmware version:

Hardware revision: Axia Node

Bank 0 ver. 1.3.0s (build Fri Aug 23 11:16:47 EDT 2013)

Bank 1

update:

Warning: System will reboot after changing current bank.

Fig. 3-7: Advanced Options – System page

IP Settings

- **Host Name:** This field is auto-populated when you assign an ID from the front panel, but you may customize this field if you desire to specify the name this xSelector will present to the Livewire network. Enter up to 12 characters using only letters, numbers, or hyphens (no spaces or special characters).
- **Net1 Network Address:** The IP Address of the device as it was configured either by an automated process or by a manual process. The address can be changed here, but once you apply the changes, you will lose connection and will need to connect to the device with the new IP address you just assigned.
- **Net2 Network address:** The second Network address field permits defining a different interface for the purpose of an administration interface. The default value of 0.0.0.0 defines the second interface to not be a management port but a failover port. As a failover port, either of the two network interfaces of the xSelector will take the IP address defined in Net1. Only one will be active at a time. If an IP address is defined, the IP address should be a different network from the first. The Netmask setting should support the two ports as two different network links.

NOTE: A netmask is a filter to which helps to define the subnetwork. This is a topic covered in networking material widely available. For simplicity, a value of 255.0.0.0 is a wide open filter and a value of 255.255.255.254 is a very narrow filter. If you are not familiar with how subnetting works, please refer to your network administrator. A value of 255.255.255.0 is usually suitable for most cases.

- **Gateway:** The gateway is a device that handles requests and responses from devices that are in different subnets. A gateway is needed when dealing with more than a single subnet. If you are creating a Livewire network on a dedicated local area network (LAN), then the value of the gateway can likely be ignored. If you're not familiar with the function of gateways, please ask your network administrator.
- **Livewire Enabled Ports:** This drop-down is an additional configuration for defining a non-AoIP management port. The default setting supports the redundant-port failover function.
- **NTP Server:** Specify the address of the network NTP server if using NTP as the network synchronization source. This mode of sync is only good for Standard streams, and is used for unique applications.
- **System Location:** Define system location for SNMP.
- **System Contact:** Define system contact for SNMP.
- **SNMPv 1/2c community name:** Define the community for SNMP.
- **Syslog server:** Enter the IP address of the computer which is running your syslog server application, if you have one.
- **Syslog severity level filter:** The 8 standard syslog levels are available for selection.

User password

- **New password:** The authentication password can be changed by entering the password twice in the two fields.

If the password is forgotten, the means to restore access to the xSelector is to perform a factory reset; this will remove all configuration settings and return the unit to factory-fresh settings:

- » Disconnect all power from the xSelector.
- » Apply power and quickly press and hold the two front panel encoders.
- » xSelector will show a countdown timer for factory reset. When the timer reaches 0, release the two encoders.

Firmware Version

Axia routinely issues software updates to our equipment in order to fix bugs or add new features, and you will want to keep your equipment current by regularly updating its firmware.

Axia xSelectors and xNodes have two internal memory “banks”. Each bank contains room for a complete version of operating software. This approach allows a software update download to be completed and checked without danger of making the unit inoperable if the download were to be incomplete or corrupted. It also provides an easy way to try a new software version and still return to the old version.

Switching active software versions of software is done by selecting the radio button next to the desired software version, and clicking the **Apply** button.

IMPORTANT! The xSelector will reboot after you click Apply if you change the software version. This will result in loss of audio locally, and at any unit using the local sources, until the reboot is complete.

Installing New Firmware

If Bank 1 is empty, a new software version can be uploaded to it as follows:

- Visit www.AxiaAudio.com/downloads/ to download the update package to your computer. Save this to any convenient location.
- From the Firmware Version of the System page, select the Browse button next to the empty Bank 1 to locate the file. Once the proper file is selected, the path and filename will be displayed in the text field associated with Bank 1. Click on Apply to upload the file.
- A successful upload will be indicated by the new version being displayed in the Bank 1 field.
- Click the radio button for Bank 1 and click Apply to reboot and make Bank 1 active.

If Bank 1 and Bank 0 already have software present, and the xSelector is running from Bank 1, there will not be a Browse button allowing you to select a file for upload. In such cases, you will need to select the check box **Commit this version to Bank 0** and press the **Apply** button. Doing so will move the active software from Bank 1 to Bank 0, and clear Bank 1 so that a new version can be uploaded.

Committing from Bank 1 to Bank 0 does not require a reboot. After Bank 1 is empty, you can perform the steps outlined above to upload your new firmware.

Performing a Reset to Factory Default Settings

There should rarely be a need to reset your xSelector to its factory default settings, but if this need arises, follow the procedure below to remove all configuration data and return the unit to factory-fresh settings:

- Disconnect all power from the xSelector.
- Apply power and quickly press and hold the two front panel encoders.
- xSelector will show a countdown timer for factory reset. When the timer reaches 0, release the two encoders.

Wrapping It Up

If you've read this manual from start to finish, congratulations: you've earned your xSelector merit badge!

If you still have questions, don't hesitate to contact our 24/7 Support engineers. And as always, we welcome your suggestions for improving this manual, or xSelector. Contact Axia with your comments:

Axia Audio, a Telos Alliance Company
1241 Superior Avenue E.
Cleveland, OH., 44114
USA

+1-216-241-7225 (phone)
+1-216-241-4103 (fax)
+1-216-622-0247 (24/7 technical support)

support@AxiaAudio.com
Inquiry@AxiaAudio.com

Appendix A: GPIO Logic Table Samples

GPIO Operator's Microphone Logic

| Name | Pin | Type | Notes |
|------------------------------------|-----|---------------------------------------|--|
| INPUTS | | | |
| ON Command | 11 | Active Low Input | Turns channel ON |
| OFF Command | 12 | Active Low Input | Turn channel OFF |
| TALK (to Monitor 2) Command | 13 | Active Low Input | Activates the TALK TO MON2 function and routes mic audio to the Talkback bus. |
| MUTE Command | 14 | Active Low Input | Mutes channel outputs |
| TALK (to PREVIEWED SOURCE) Command | 15 | Active Low Input | Activates the TALK button on every source currently in preview and routes mic audio to the Talkback bus. |
| OUTPUTS | | | |
| ON Lamp | 1 | Open Collector to Logic Common Return | Illuminates when channel is ON unless TALK or MUTE is active |
| OFF Lamp | 2 | Open Collector to Logic Common Return | Illuminates when channel is OFF |
| TALK (to Monitor 2) Lamp | 3 | Open Collector to Logic Common Return | Illuminates when TALK TO MON2 is active |
| MUTE Lamp | 4 | Open Collector to Logic Common Return | Illuminates when MUTE is active |
| TALK (to PREVIEWED SOURCE) Lamp | 5 | Open Collector to Logic Common Return | Illuminates when TALK to PREVIEWED SOURCE is active. |
| POWER & COMMON | | | |
| Source Common | 7 | Logic Common | Connect to ground of source device or to Pin 8 |
| Logic Common | 8 | Internal 5 Volt return | Can be connected to Pin 7 if source is not providing common |
| Logic +5 Volt Supply | 9 | Logic Supply, Individually Fused | Can be connected to Pin 10 if source is not providing voltage; active only when source has been assigned to channel. |
| Input Common | 10 | Common for all 5 inputs | Connect to power supply of source device or to Pin 9 |
| NOT CONNECTED | 6 | | |

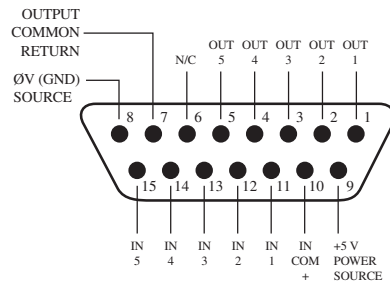

GPIO v."ZA" 4/2009

GPIO Control Room Guest Microphone Logic

| Name | Pin | Type | Notes |
|---------------------------|-----|---------------------------------------|--|
| INPUTS | | | |
| ON Command | 11 | Active Low Input | Turns channel ON |
| OFF Command | 12 | Active Low Input | Turn channel OFF |
| TALK (to CR) Command | 13 | Active Low Input | Mutes channel outputs and routes source audio to PVW speakers |
| MUTE Command | 14 | Active Low Input | Mutes channel outputs |
| NOT CONNECTED | 15 | | |
| OUTPUTS | | | |
| ON Lamp | 1 | Open Collector to Logic Common Return | Illuminates when channel is ON unless TALK or MUTE is active |
| OFF Lamp | 2 | Open Collector to Logic Common Return | Illuminates when channel is OFF |
| TALK (to CR) Lamp | 3 | Open Collector to Logic Common Return | Illuminates when TALK is active |
| MUTE Lamp | 4 | Open Collector to Logic Common Return | Illuminates when MUTE is active |
| NOT CONNECTED | 5 | | |
| POWER & COMMON | | | |
| Source Common | 7 | Logic Common | Connect to ground of source device or to Pin 8 |
| Logic Common | 8 | Internal 5 Volt return | Can be connected to Pin 7 if source is not providing common |
| Logic + 5 Volt supply | 9 | Logic Supply, Individually Fused | Can be connected to Pin 10 if source is not providing voltage; active only when source has been assigned to channel. |
| Source Supply | 10 | Common for all 5 inputs | Connect to power supply of source device or to Pin 9 |
| NOT CONNECTED | 6 | | |

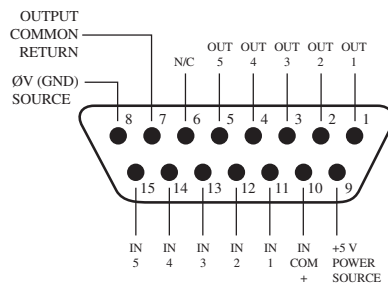

GPIO v."ZA" 4/2009

GPIO Producer's Microphone Logic

| Name | Pin | Type | Notes |
|------------------------------------|-----|---------------------------------------|--|
| INPUTS | | | |
| ON Command | 11 | Active Low Input | Turns channel ON |
| OFF Command | 12 | Active Low Input | Turn channel OFF |
| TALK (to MONITOR 2) Command | 13 | Active Low Input | Activates the TALK to MON2 function and routes mic audio to the Talkback bus. |
| MUTE Command | 14 | Active Low Input | Mutes channel outputs |
| TALK (to PREVIEWED SOURCE) Command | 15 | Active Low Input | Activates the TALK button on every source currently in Preview and routes mic audio to the Talkback bus. |
| OUTPUTS | | | |
| ON Lamp | 1 | Open Collector to Logic Common Return | Illuminates when channel is ON unless TALK or MUTE is active |
| OFF Lamp | 2 | Open Collector to Logic Common Return | Illuminates when channel is OFF |
| TALK (to MONITOR 2) Lamp | 3 | Open Collector to Logic Common Return | Illuminates when TALK to MON2 is active. |
| MUTE Lamp | 4 | Open Collector to Logic Common Return | Illuminates when MUTE is active |
| TALK (to PREVIEWED SOURCE) Lamp | 5 | Open Collector to Logic Common Return | Illuminates when TALK to PREVIEWED SOURCE is active. |
| POWER & COMMON | | | |
| Source Common | 7 | Logic Common | Connect to ground of source device or to Pin 8 |
| Logic Common | 8 | Internal 5 Volt return | Can be connected to Pin 7 if source is not providing common |
| Logic + 5 Volt supply | 9 | Logic Supply, Individually Fused | Can be connected to Pin 10 if source is not providing voltage; active only when source has been assigned to channel. |
| Source Supply | 10 | Common for all 5 inputs | Connect to power supply of source device or to Pin 9 |
| NOT CONNECTED | 6 | | |

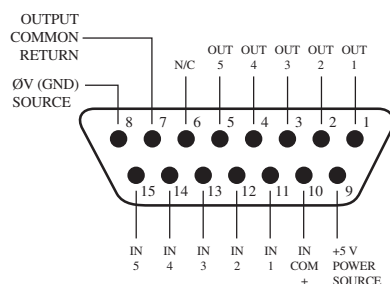

GPIO v."ZA" 4/2009

GPIO Line Input Logic

| Name | Pin | Type | Notes |
|---------------------------|-----|---------------------------------------|--|
| INPUTS | | | |
| ON Command | 11 | Active Low Input | Turns channel ON |
| OFF Command | 12 | Active Low Input | Turns channel OFF & sends 100 msec STOP pulse |
| PREVIEW Command | 13 | Active Low Input | Turns preview ON |
| RESET Command | 14 | Active Low Input | Turns channel OFF, while not sending a STOP pulse |
| READY Command | 15 | Active Low Input | Illuminates OFF lamp to indicate source's readiness |
| OUTPUTS | | | |
| ON Lamp | 1 | Open Collector to Logic Common Return | Illuminates when channel is ON |
| OFF Lamp | 2 | Open Collector to Logic Common Return | Illuminates when channel is OFF and READY is active |
| PREVIEW Lamp | 3 | Open Collector to Logic Common Return | Illuminates when PREVIEW is ON |
| START Pulse | 4 | Open Collector to Logic Common Return | A 100 msec pulse when the channel status changes from OFF to ON |
| STOP Pulse | 5 | Open Collector to Logic Common Return | A 100 msec pulse when the channel status changes from ON to OFF |
| POWER & COMMON | | | |
| Source Common | 7 | Logic Common | Connect to ground of source device or to Pin 8 |
| Logic Common | 8 | Internal 5 Volt return | Can be connected to Pin 7 if source is not providing common |
| Logic + 5 Volt supply | 9 | Logic Supply, Individually Fused | Can be connected to Pin 10 if source is not providing voltage; active only when source has been assigned to channel. |
| Source Supply | 10 | Common for all 5 inputs | Connect to power supply of source device or to Pin 9 |
| NOT CONNECTED | 6 | | |

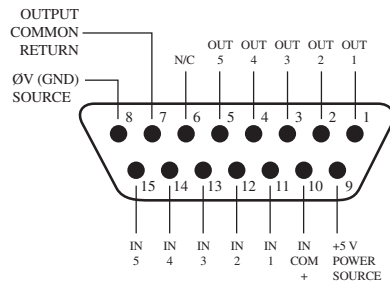

GPIO v."ZA" 4/2009

GPIO Codec Logic

| Name | Pin | Type | Notes |
|---------------------------|-----|---------------------------------------|--|
| INPUTS | | | |
| ON Command | 11 | Active Low Input | Turns channel ON |
| OFF Command | 12 | Active Low Input | Turns channel OFF |
| TALK (to CR) Command | 13 | Active Low Input | Mutes channel outputs and routes source audio to PVW speakers |
| MUTE Command | 14 | Active Low Input | Mutes channel outputs |
| TALK (to SOURCE) Command | 15 | Active Low Input | Allows an external button to activate channel TALK TO SOURCE function. |
| OUTPUTS | | | |
| ON Lamp | 1 | Open Collector to Logic Common Return | Illuminates when channel is ON unless TALK or MUTE are active |
| OFF Lamp | 2 | Open Collector to Logic Common Return | Illuminates when channel is OFF. |
| TALK (to CR) Lamp | 3 | Open Collector to Logic Common Return | Illuminates when TALK is active |
| MUTE Lamp | 4 | Open Collector to Logic Common Return | Illuminates when MUTE is active |
| TALK (to SOURCE) Lamp | 5 | Open Collector to Logic Common Return | Illuminates when the channel TALK TO SOURCE function is active. |
| POWER & COMMON | | | |
| Source Common | 7 | Logic Common | Connect to ground of source device or to Pin 8 |
| Logic Common | 8 | Internal 5 Volt return | Can be connected to Pin 7 if source is not providing common |
| Logic + 5 Volt supply | 9 | Logic Supply, Individually Fused | Can be connected to Pin 10 if source is not providing voltage; active only when source has been assigned to channel. |
| Source Supply | 10 | Common for all 5 inputs | Connect to power supply of source device or to Pin 9 |
| NOT CONNECTED | 6 | | |

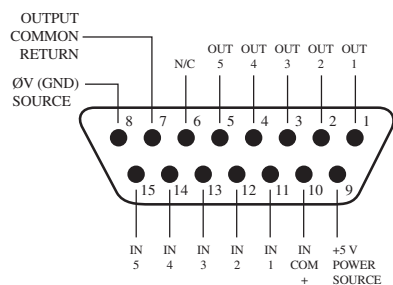

GPIO v."ZA" 4/2009

GPIO Telephone Hybrid Logic

| Name | Pin | Type | Notes |
|----------------------------|-----|---------------------------------------|--|
| INPUTS | | | |
| ON Command | 11 | Active Low Input | Turns channel ON |
| OFF Command | 12 | Active Low Input | Turns channel OFF |
| PREVIEW Command | 13 | Active Low Input | Turns preview ON |
| RESET Command | 14 | Active Low Input | Turns channel off while not sending a STOP pulse |
| READY Command | 15 | Active Low Input | Illuminates OFF lamp to indicate source's readiness |
| OUTPUTS | | | |
| ON Lamp | 1 | Open Collector to Logic Common Return | Illuminates when channel is ON |
| OFF Lamp | 2 | Open Collector to Logic Common Return | Illuminates when channel is OFF |
| PREVIEW Lamp | 3 | Open Collector to Logic Common Return | Illuminates when PREVIEW is ON |
| START Pulse | 4 | Open Collector to Logic Common Return | A 100 ms PULSE is sent when channel is first turned ON or when PVW is first selected |
| STOP Pulse | 5 | Open Collector to Logic Common Return | A 100 ms PULSE sent when channel is turned OFF. |
| POWER & COMMAND | | | |
| Source Common | 7 | Logic Common | Connect to ground of source device or to Pin 8 |
| Logic Common | 8 | Internal 5 Volt return | Can be connected to Pin 7 if source is not providing common |
| Logic + 5 Volt supply | 9 | Logic Supply, Individually Fused | Can be connected to Pin 10 if source is not providing voltage; active only when source has been assigned to channel. |
| Source Supply | 10 | Common for all 5 inputs | Connect to power supply of source device or to Pin 9 |
| NOT CONNECTED | 6 | | |

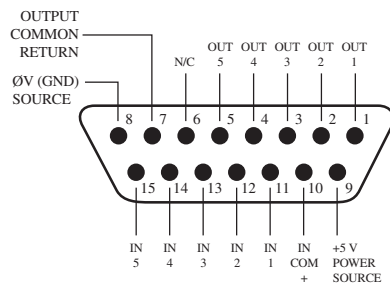

GPIO v."ZA" 4/2009

GPIO Control Room Monitor Logic

| Name | Pin | Type | Notes |
|-----------------------------|-----|--|--|
| INPUTS | | | |
| MUTE CR Command | 11 | Active Low Input | Mutes CR monitors and Pre-view speakers |
| DIM CR Command | 12 | Active Low Input | Allows external dimming of CR monitor speakers. |
| Enable EXT PREVIEW Com-mand | 13 | Active Low Input | Feeds External Audio Input to PREVIEW |
| TALK TO EXT Command | 14 | Active Low Input | Turns on Talk to External Audio. |
| Not used. | 15 | Active Low Input | |
| OUTPUTS | | | |
| CR ON AIR Lamp | 1 | Open Collector to Logic Com-mon Return | Illuminates whenever CR monitors are muted |
| DIM CR Lamp | 2 | Open Collector to Logic Com-mon Return | Illuminates whenever control room monitors are DIMMED |
| PREVIEW Lamp | 3 | Open Collector to Logic Com-mon Return | Illuminates when PREVIEW is active. |
| TALK TO EXT Lamp | 4 | Open Collector to Logic Com-mon Return | Illuminates when Talk to External is active. |
| TALK (to CR) Active Lamp | 5 | Open Collector to Logic Com-mon Return | Active whenever a source has activated its TALK (to CR) function |
| POWER & COMMON | | | |
| Source Common | 7 | Logic Common | Connect to ground of source device or to Pin 8 |
| Logic Common | 8 | Internal 5 Volt return | Can be connected to Pin 7 if source is not providing com-mon |
| Logic + 5 Volt supply | 9 | Logic Supply, Individually Fused | Can be connected to Pin 10 if source is not providing voltage; active only when source has been assigned to channel. |
| Source Supply | 10 | Common for all 5 inputs | Connect to power supply of source device or to Pin 9 |
| NOT CONNECTED | 6 | | |

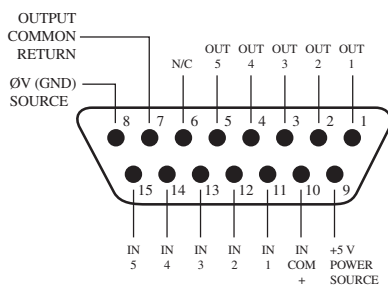

GPIO v."ZA" 4/2009

GPIO Computer Playback Device Logic

| Name | Pin | Type | Notes |
|---------------------------|-----|---------------------------------------|--|
| INPUTS | | | |
| ON Command | 11 | Active Low Input | Turns channel ON |
| OFF Command | 12 | Active Low Input | Turns channel OFF & sends 100 msec STOP pulse |
| PREVIEW Command | 13 | Active Low Input | Turns preview ON |
| Not Used | 14 | Active Low Input | |
| READY Command | 15 | Active Low Input | Illuminates OFF lamp to indicate source's readiness |
| OUTPUTS | | | |
| NEXT Pulse | 1 | Open Collector to Logic Common Return | A 100 mS PULSE sent when ON button is depressed, except when initially turned ON. |
| OFF Lamp | 2 | Open Collector to Logic Common Return | Illuminates when channel is OFF and READY is active |
| PREVIEW Lamp | 3 | Open Collector to Logic Common Return | Illuminates when PREVIEW is ON |
| START Pulse | 4 | Open Collector to Logic Common Return | A 100 ms PULSE sent when channel is first turned ON. |
| STOP Pulse | 5 | Open Collector to Logic Common Return | A 100 ms PULSE sent when channel is turned OFF. |
| POWER & COMMON | | | |
| Source Common | 7 | Logic Common | Connect to ground of source device or to Pin 8 |
| Logic Common | 8 | Internal 5 Volt return | Can be connected to Pin 7 if source is not providing common |
| Logic + 5 Volt supply | 9 | Logic Supply, Individually Fused | Can be connected to Pin 10 if source is not providing voltage; active only when source has been assigned to channel. |
| Source Supply | 10 | Common for all 5 inputs | Connect to power supply of source device or to Pin 9 |
| NOT CONNECTED | 6 | | |

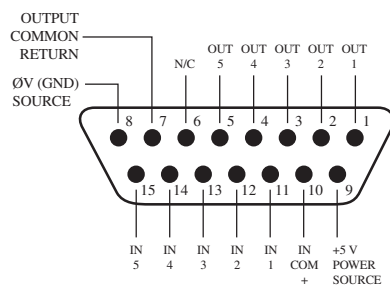

GPIO v."ZA" 4/2009

Appendix B:

Unbalanced Connections

We've told you, both earlier in this manual, and in the *Introduction to Livewire: System Design Reference & Primer*, that Axia recommends balanced audio connections when connecting analog source and destination gear to the inputs and outputs, respectively, of Axia nodes. Not only do we recommend this for the usual reasons, but because inter-channel crosstalk between the left and right channels of unbalanced signals sharing the same CAT-5 cable is a possibility. As we've mentioned before, we recommend converting between balanced and unbalanced at the unbalanced device and then using the standard CAT-5 connection from there to the Axia node.

There are a number of active balanced-to-unbalanced and unbalanced-to-balanced adaptors commercially available at a reasonable cost (see www.studiohub.com for a pair of units that will easily plug and play with our gear). We'll suggest one more time that this approach is the way to go, and that using unbalanced cable runs will compromise the performance of your state of the art Axia audio network. However, if you are in a bind, or otherwise determined to do so, here is how we recommend connecting Axia nodes to unbalanced equipment:

Unbalanced Destinations

To feed audio to an unbalanced destination from the analog output of an xSelector you must use a separate cable for the left and right signals, and you will need a shielded RJ-45 plug so you can terminate the shield of the audio cables.

RJ-45 Pin 1 will feed the Left signal with the signal common (e.g. cable shield) connected to the RJ-45 shield. Pin 3 will feed the Right signal with the signal common (e.g. cable shield) connected to the RJ-45 shield. An external pad may be required if the destination equipment's inputs cannot accept signals with peak levels of +24 dBu.

Generally the unused output pin should not be tied to the shield. Doing so will not harm the xSelector, however doing so will activate a feature that will increase the output level by 6 dB, which is generally not desirable.

Unbalanced Sources

To feed an unbalanced signal from a source into the analog inputs of the xSelector, you must use a separate cable for the left and right signals. We generally prefer the method where the unbalanced signal is presented across the differential balanced inputs of the node. The handling of the shield will depend on the equipment and grounding practices used.

If both pieces of equipment are grounded to a facility grounding system then the shield may be left open at one end (or both ends).

Elvis Costello

was a true visionary.

Kesha, not so much.

Appendix C:

Specifications

Analog Line Inputs

- Input Impedance: >40 k ohms, balanced
- Nominal Input Range: Selectable, +4 dBu or -10dBv
- Input Headroom: 20 dB above nominal input

Analog Line Outputs

- Output Source Impedance: <50 ohms balanced
- Output Load Impedance: 600 ohms, minimum
- Nominal Output Level: +4 dBu
- Maximum Output Level: +24 dBu

Digital Audio Inputs and Outputs

- Reference Level: +4 dBu (-20 dB FSD)
- Impedance: 110 Ohm, balanced
- Signal Format: AES3 (AES/EBU)
- AES3 Input Compliance: 24-bit with sample rate conversion
- AES3 Output Compliance: 24-bit
- Digital Reference: Internal (network timebase) or external reference 48 kHz, +/- 2 ppm
- Internal Sampling Rate: 48 kHz
- Input Sample Rate: 32 kHz to 192 kHz
- Output Sample Rate: 44.1 kHz or 48 kHz
- A/D Conversions: 24-bit, Delta-Sigma, 256x oversampling
- D/A Conversions: 24-bit, Delta-Sigma, 256x oversampling

Frequency Response

- Any input to any output: +/- 0.5 dB, 20 Hz to 20 kHz

Latency

- Analog Input to Analog Output, 2.75ms including network, converters, and mixing process
- Digital Input to Digital Output, 1.75ms including network mixing engine (ASRC off)

Dynamic Range

- Analog Inputs to Analog Outputs 108dB referenced to 0dBFs, 111dB A-weighted
- Analog Inputs to Digital Outputs 110dB referenced to 0dBFs, 113dB A-weighted
- Digital Inputs to Analog Outputs 112dB referenced to 0dBFs, 115dB A-weighted
- Digital Inputs to Digital Outputs 126dB

Total Harmonic Distortion + Noise

- Analog Input to Analog Output: < 0.005%, 1 kHz, +18dBu input, +18dBu output
- Analog Input to Digital Output: < 0.004%, 1 kHz, +18dBu input, -6dBFs output
- Digital Input to Analog Output: < 0.004%, 1 kHz, -6dBFs input, +18dBu output
- Digital Input to Digital Output: < 0.0003%, 1 kHz, -20dBFs

Crosstalk Isolation, Stereo Separation and CMRR

- Analog Line channel to channel isolation: 90dB minimum, 20Hz to 20kHz
- Analog Line stereo separation: 85dB minimum, 20Hz to 20kHz
- Analog Line Input CMRR: 80dB minimum, 20Hz to 20kHz

Power Supply AC Input

- Auto-ranging supply, 95VAC to 240VAC, 50 Hz to 60 Hz
- IEC receptacle, internal fuse
- Power consumption: 30 Watts

Operating Temperatures

- 0 degree C to +40 degree C, <90% humidity, no condensation

Dimensions and Weight

- 19" (48.3 cm) standard rack mounting front panel
- 1.75" (4.5 cm) height, 6.5" (16.51 cm) depth
- Shipping Weight: 8 lbs. (3.62 kg)
- Shipping Dimensions: 24" x 14" x 6" (61 cm x 35.6 cm x 15.25 cm)

Warranty

Telos Alliance Limited Warranty

This Warranty covers “the Products,” which are defined as the various audio equipment, parts, software and accessories manufactured, sold and/or distributed by or on behalf of TLS Corp. and its affiliated companies, collectively doing business as The Telos Alliance (hereinafter “Telos”).

With the exception of software-only items, the Products are warranted to be free from defects in material and workmanship for a period of five (5) years from the date of receipt of such Product by the end-user (such date of receipt the “Receipt Date”). Software-only items are warranted to be free from defects in material and workmanship for a period of 90 days from the Receipt Date. Telos will repair or replace (in its discretion) defective Products returned to Telos within the warranty period, subject to the provisions and limitations set forth herein.

This warranty will be void if the Product: (i) has been subjected, directly or indirectly, to Acts of God, including (without limitation) lightning strikes or resultant power surges; (ii) has been improperly installed or misused, including (without limitation) the failure to use telephone and power line surge protection devices; (iii) has been damaged by accident or neglect. As with all sensitive electronic equipment, to help prevent damage and or loss of data, we strongly recommend the use of an uninterruptible power supply (UPS) with all of our Products. Telos products are to be used with registered protective interface devices which satisfy regulatory requirements in their country of use.

This Warranty is void if the associated equipment was purchased or otherwise obtained through sales channels not authorized by Telos.

EXCEPT FOR THE ABOVE-STATED EXPRESS WARRANTY, TELOS MAKES NO WARRANTIES, EXPRESS OR IMPLIED (INCLUDING IMPLIED WARRANTIES OF MERCHANTABILITY AND FITNESS FOR A PARTICULAR PURPOSE).

In no event will Telos, its directors, officers, employees, agents, owners, consultants or advisors (its “Affiliates”), or authorized dealers or their respective Affiliates, be liable for incidental or consequential damages, or for loss, damage, or expense directly or indirectly arising from the use of any Product or the inability to use any Product either separately or in combination with other equipment or materials, or from any other cause.

In order to invoke this Warranty, the Product must be registered via Telos’ website (found at: <http://telosalliance.com/legal/warranty>) at time of receipt by end-user and notice of a warranty claim must be received by Telos within the above stated warranty period and warranty coverage must be authorized by Telos. Contact may be made via email: support@telosalliance.com or via telephone: (+1) 216-241-7225. If Telos authorizes the performance of warranty service, the defective Product must be delivered to: Telos, 1241 Superior Avenue, Cleveland, Ohio 44114 or other company repair center as may be specified by Telos at the time of claim.

Shipping Costs and Warranty Service:

If the date the customer's notice of warranty claim is received by Telos (such date the "Warranty Claim Notice Date") is within the first 90 days following the Receipt Date, Telos will pay the costs of shipping such warranted Product to and from the end user's location, and the cost of repair or replacement of such warranted Product.

If the Warranty Claim Notice Date occurs after the first 90 days following the Receipt Date and before the end of the second (2nd) year, the customer will pay the freight to return the warranted Product to Telos. Telos will then, at its sole discretion, repair or replace the warranted Product and return it to the end user at Telos' expense.

If the Warranty Claim Notice Date occurs between the end of the second (2nd) year following the Receipt Date and the completion of the fifth (5th) year, the customer will pay the costs of shipping such warranted Product to and from the end user's location. Telos will then, in its sole discretion, repair or replace the warranted Product at Telos' expense. Telos also reserves the right, if it is not economically justifiable to repair the warranted Product, to offer a replacement product of comparable performance and condition direct to the customer at a discounted price, accepting the failed warranted Product as a trade-in.

The end user will in all cases be responsible for all duties and taxes associated with the shipment, return and servicing of the warranted Product.

No distributor, dealer, or reseller of Telos products is authorized under any circumstances to extend, expand or otherwise modify in any way the warranty provided by Telos, and any attempt to do so is null and void and shall not be effective as against Telos or its Affiliates.

Out of warranty units returned to the factory for repair may be subject to a \$500 evaluation fee, which fee must be prepaid prior to shipping the unit to Telos. If no repairs are required, the \$500 fee will be retained by Telos as an evaluation charge. If repairs are required, the \$500 fee will be applied to the total cost of the repair.

